

JET HAND DRYER
INSTRUCTION MANUAL

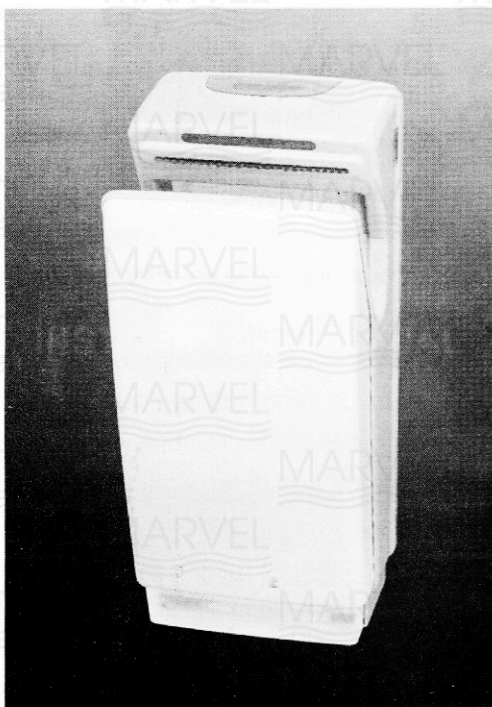

GENERAL

1. It is important these installation and maintenance instructions are fully adhered to. Following these instructions will ensure proper function and safety.
2. All electrical installation must be carried out by a suitably qualified and competent person.
3. This hand dryer must be installed out of arms reach from sink, bath etc.
4. Never spray water directly onto hand dryer.
5. Do not cover air inlets and/or air outlets.
6. If the power cord is damaged, it must be replaced by the manufacturer or a similar qualified person in order to prevent any risk. Means for disconnection must be incorporated in the fixed wiring in accordance with the wiring rules.
7. In the event of malfunction or damage, immediately disconnect from power supply and contact a qualified electrician for repair.
8. The use of every electrical appliance calls for the awareness of some basic rules, such as:
 - never use the hand dryer while barefoot.
 - do not use extension leads in bath or shower rooms.
 - never pull the power cable or the hand dryer itself when unplugging the plug and never expose the hand dryer to atmospheric conditions (rain, sun, etc.)
 - it is not intended to be used by people (including children) with reduced physical, sensorial or mental capabilities, or without any experience or knowledge, unless they can benefit from supervision or instructions about how to use the hand dryer by someone responsible for their safety. Young children should be supervised to ensure that they do not play with the hand dryer.

COMPONENTS

1. LCD screen
2. sensor
3. sensor
4. power switch
5. front cover
6. tray

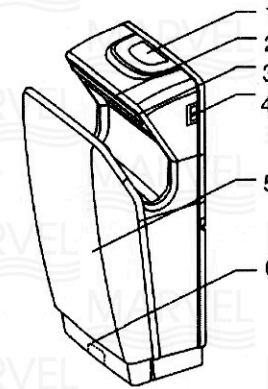
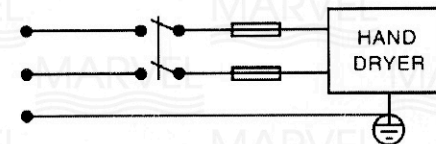

fig.1

INSTALLATION

WARNING – The hand dryer must be earthed in accordance with the local regulations. Failure to properly ground unit could result in severe electrical shock and/or death. The hand dryer must be isolated from the power supply during installation and maintenance.

Note: A two-pole switch should be fitted between the hand dryer and the power supply cable (see External Wiring Diagram). The terminal gauge should be larger than 3mm.



External Wiring Diagram

1. Switch off power supply and make sure it can not be switched back on before installation finish.
2. Place template against wall at desired height (see RECOMMENDED MOUNTING HEIGHTS) and mark locations of 5 mounting holes and power cord entry at knockout location (see fig.3).

Note: for two or more dryers, dryers should be no closer than 610 mm (24 inches) on centre.

3. Remove and retain 2 side screws, 2 plastic caps and hanger board (see fig.2).
4. Fix hanger board to the wall by using the screws and wall plugs included (see fig.3).
5. Remove and retain tray, 2 cover screws and cover (see fig.2).
6. Hang the hand dryer and fix with 2 side screws then replace 2 plastic caps.
7. Connect power cord to terminal block where indicated (see fig.2).

Connections:

- A. Connect the live wire (Brown or Red) to the terminal block marked "L".
- B. Connect the neutral wire (Blue or Black) to the terminal block marked "N".
- C. Connect the ground wire (Green and Yellow) to the terminal block marked "⊖".

Note: Refer to the appropriate wiring diagram. Ensure that all earth connections are made.

8. Replace cover. Do not over-tighten screws. Replace tray.

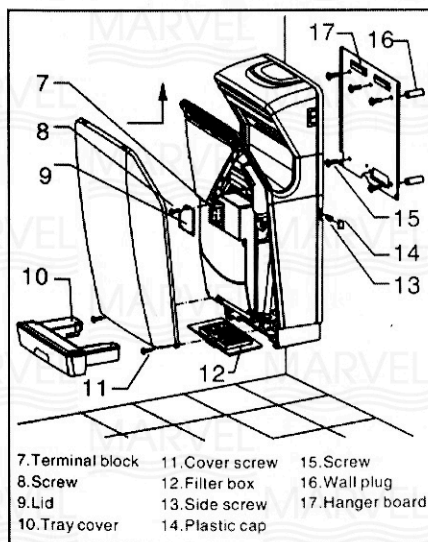

fig.2

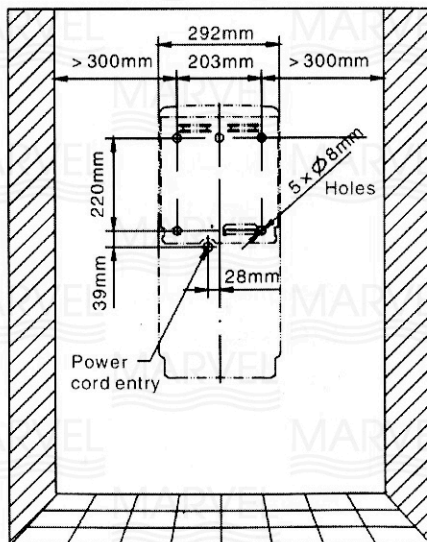

fig.3

RECOMMENDED MOUNTING HEIGHTS

From floor to bottom of dryer.

Men	Ladies	Children ages 11-17	Children ages 3-10	Disabled
13"	11"	10"	6"	4"
350mm	300mm	250mm	150mm	100mm

START-UP

1. Turn on hand dryer.
2. LCD screen displays (see fig.4)
 - Dryer operating
 - Drying instruction
 - Count-down in seconds

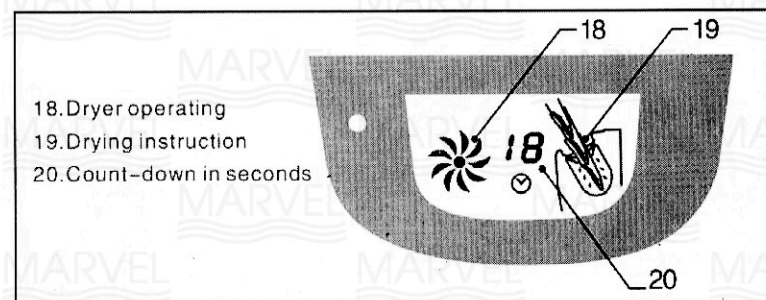

fig.4

OPERATION

- No-touch operation.
- Shake excess water from hands.
- Place hands into the aperture (see fig.5).
- Move hands up and down.
- Hand dryer stops automatically after hands are removed.

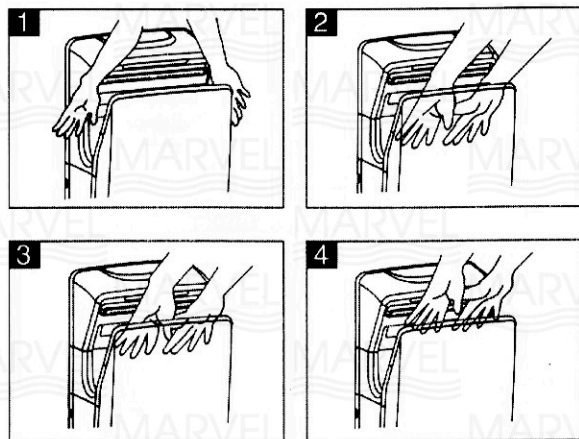

fig.5

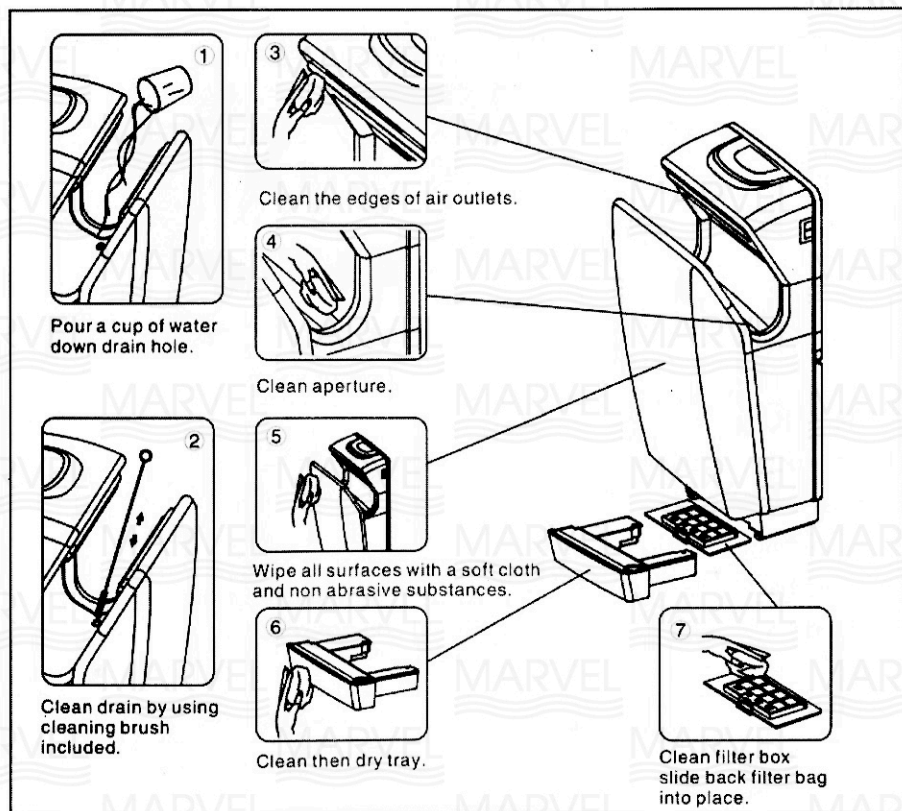

fig.6

MAINTENANCE

Periodic cleaning of the unit is recommended to ensure optimum performance (see fig.6).

- Disconnect the electrical supply.
- Pour a cup of water down drain hole. Clean drain by using included cleaning brush.
- Wipe the cover with a soft cloth and mild cleaning solution. Do not soak. Never use abrasives to clean the cover.
- Do not drench surface directly with any kind of sanitizer.
- Disassemble tray, clean and dry it.
- Clean filter box with a soft cloth and mild cleaning solution. Do not soak. Slide back filter bag into place. Recommend replace a new filter bag when air velocity drops.
- Recommend do the cleaning every week.

ADDITIONAL ACCESSORIES

1. Remove filter box, open its cover, there is a filter bag inside. It can prevent blockage of dust lint comes from air inlet. Please contact our distributors to order this filter bag (see fig.7).
2. There are 2 grids in filter box. A solid perfume can be put here to bring fresh air while drying hands (see fig.7).
3. This filter bag is antibacterial. It can absorb harmful gases as well (see fig.8).

CAUTION: Operate the hand dryer without filter bag will cause ineffective dryer operation or eventually fail.

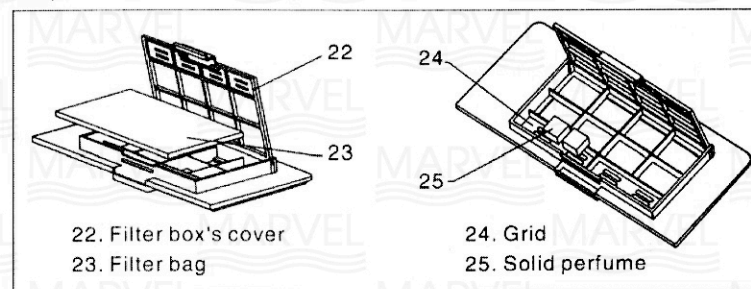

fig.7

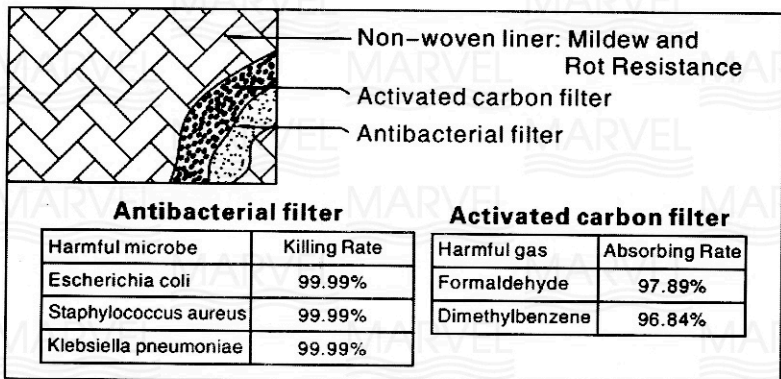
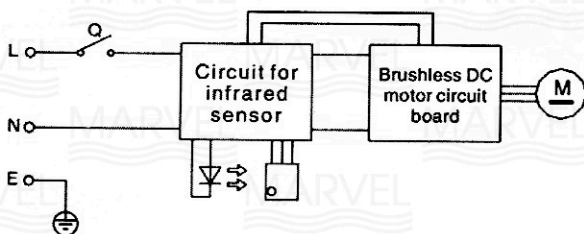

fig.8

SPECIFICATIONS

Voltage	Power	Frequency	Water Splash Proof
110V~/120V~	850W	50Hz/60Hz	IP22
220V~/230V~/240V~			



Internal Wiring Diagram

PACKAGE

- One hand dryer
- One copy of instruction manual
- One installation template
- One cleaning brush
- One filter bag
- Pack containing: 5 × screws, 5 × wall plugs (Ø 8mm)